

Dynapac F2500C

Tracked pavers

Atlas Copco





Technical data

 Masses	
Weight (incl. standard screed)	18 t

 Dimensions	
Basic width	2.55 m
Working width, max.	8.10 m
Working width, minimum (with reducing shoe)	2.05 m
Front ramp angle	15°

 Capacity	
Placement thickness (max)	310 mm
Theoretical placement capacity	650 t/h

 Material hopper	
Capacity	6.0 m ³
Dumping height (center/outside)	555mm/560mm
Hopper width, internal	3,292 mm

 Traction	
Maximum paving speed	30 m/min
Transport speed	4 km/h

 Engine	
Manufacturer/Model	Cummins QSB 6.7 -C173
Emissions according to	Stage IIIA (Tier 3)
Rated power, SAE J1995	110 kW @2,200 rpm with stepless rpm control
Electrical system	24 V
Fuel tank capacity	320 l

 Undercarriage	
Crawler length	2,900 mm
Crawler width	320 mm

 Conveyor	
Conveyor type	Dual bar feeder
Conveyor width	2 x 655mm
Conveyor control	Automatic with limit switches

 Auger	
Auger diameter	380 mm
Auger control	Automatic with ultrasonic sensors

Find us locally at www.atlascopco.com

We reserve the right to change specifications without notice. Photos and illustrations do not always show standard versions of machines. The above information is a general description only, all informations are supplied without liability.

rce_f2500c_en-20150603.090313.pdf 2015-06-03 09:03

Dynapac F2500C

Tracked pavers

Atlas Copco

Technical data

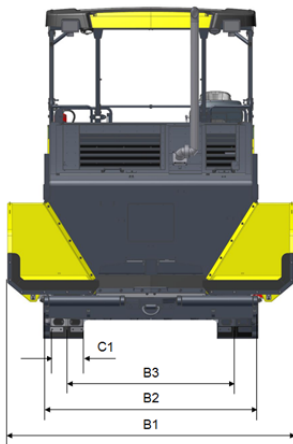
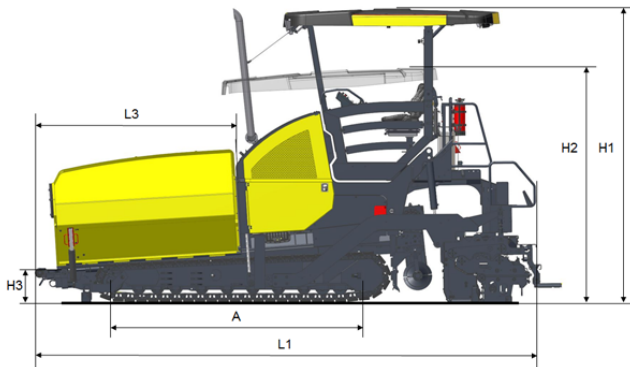

Dimensions	
A. Axle track	2,900 mm
B1. Width, max.	3,400 mm
B2. Width, standard	2,550 mm
B3. Width, center of tracks	1,992 mm
C1. Track width	320 mm
H1. Height, max.	3,900 mm
H2. Height, transport	3,100 mm
H3. Height	492 mm
L1. Length	6,145 mm
L3. Length, hopper	2,123 mm

Find us locally at www.atlascopco.com

We reserve the right to change specifications without notice. Photos and illustrations do not always show standard versions of machines. The above information is a general description only, all informations are supplied without liability.

rce_f2500c_en-20150603.090313.pdf 2015-06-03 09:03